

# WEAVING FRAME - LARGE -

Weaving width 70cm x 50cm (27" x 19")

## Simple and effective

- wonderful introduction to weaving
- very quick to warp and weave
- strong
- compact

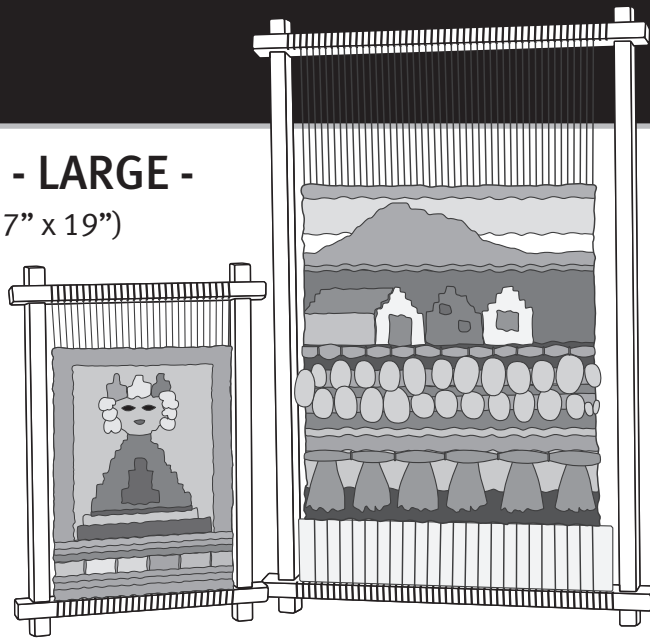

## 1. Assembly

The weaving frame will fit together very easily. No need for nails or screws.

Slide the short ends into the long ends. Make sure the long shallow groove is to the outside.

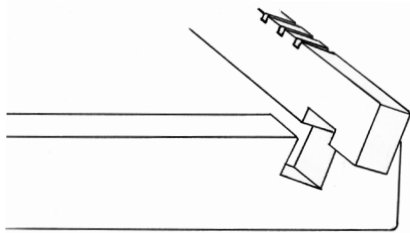

## 2. Threading

Lie the loom on a table. Decide the width you will weave. Tie a knot to secure. Take a thread across the loom around other end. Continue backwards and forwards until width is correct. **Note: Do not make warp too tight.** Tie a knot to secure and cut the thread.

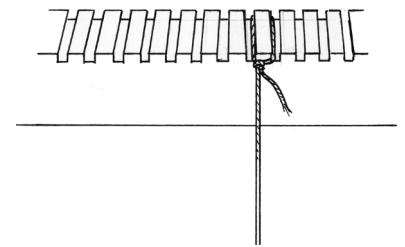

## 4. Starting To Weave

Take a narrow piece of cardboard. Weave through the threads. Push it to the bottom of the loom. Now you can begin weaving. Weave the first row of weaving against the cardboard.

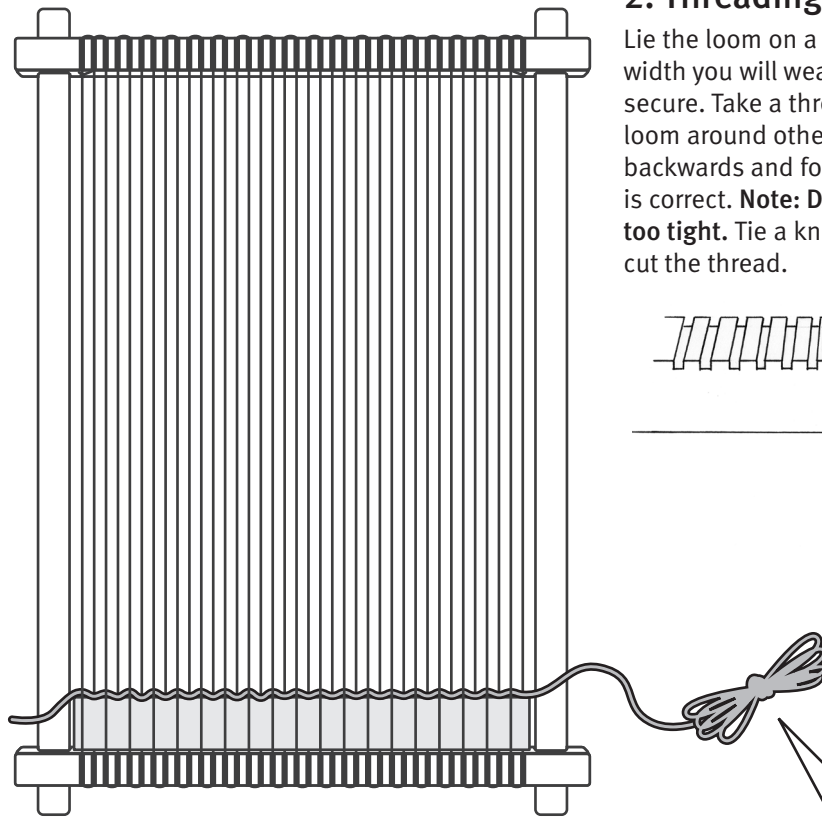

## 4. Make small butterflies

This is used instead of a shuttle, when using many colours. The yarn automatically unwinds from the centre as you weave.

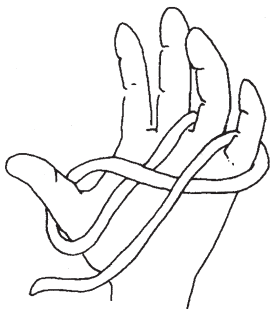

1 To make a butterfly, first place the end between the middle and ring finger of either hand leaving a tail.

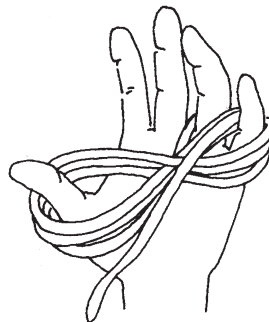

2 Keeping your fingers slightly spread, stack the revolutions one on top of another.

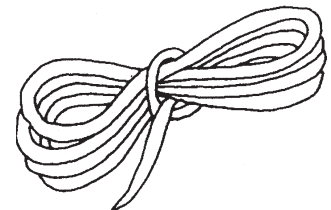

3 Leave the last wrap loose and slip the end of the yarn through the loop, then pull the end until it is snug.

## Designing Your Masterpiece

You can weave a fantasy. Just weave from your heart changing the colours as you feel for an original piece.

Or take a piece of paper the size of your weaving space. Draw a design of your choice. Secure the paper to a piece of cardboard the same size (24x33.5cm approx). Following the design on your paper, carefully ink on the pattern to the threads on the loom. Use a water resistant felt marker pen.

## Useful Hints

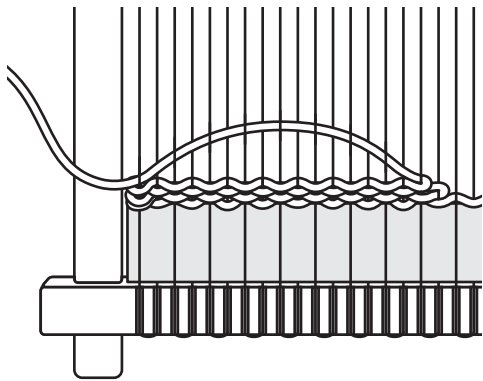

\* When placing in the weft threads, make little hills with the yarn across the row.

\* Beat the threads into place with a tapestry beater, a dinner fork or use your fingertips.

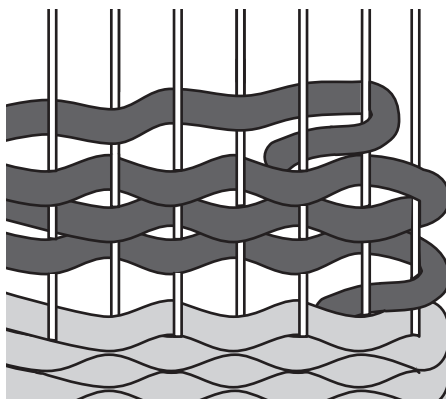

\* To start and finish each colour leave out 2-3cm (1in) weft thread at the back of the work.

\* Each thread fits together into the woven structure like a jigsaw puzzle, only the weft is visible.

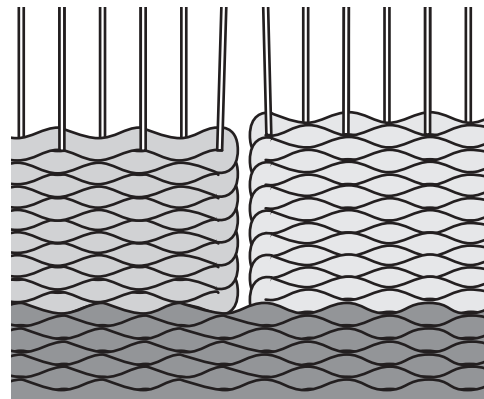

\* When one square sits beside another there will be a clear line. Do not interlock the threads.

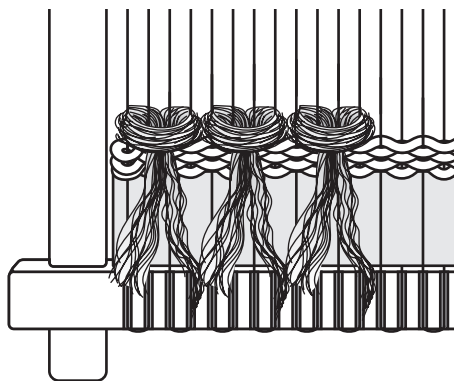

\* Try to mix different materials e.g. fleece, wool sliver, cotton shoelace, fancy yarn... by using the knot.

\* **Be creative** – use different textures of yarn – handspun fibre is great! Spin chunky singles or novelty yarns.

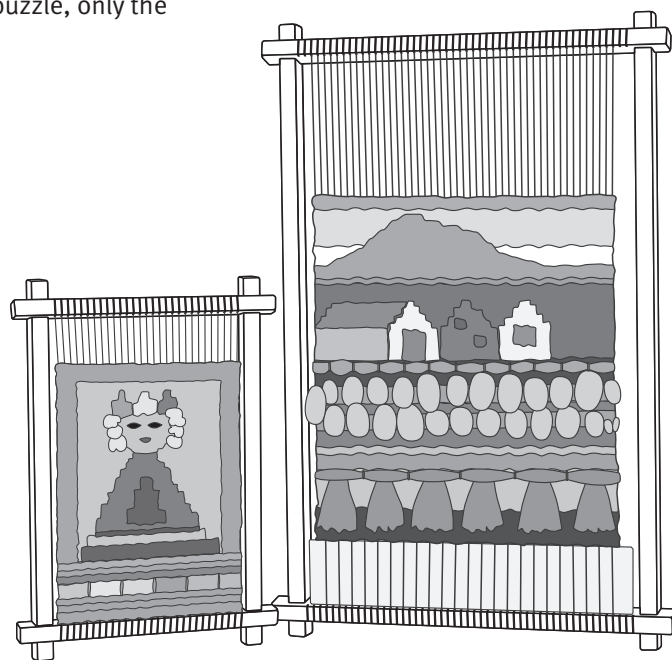
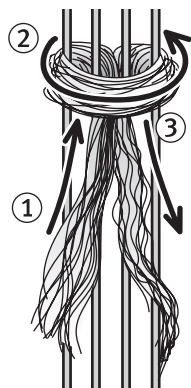

WFL010218V6

## More Information



### How-to videos on You Tube

Watch our how-to videos on You Tube.  
[www.youtube.com/user/AshfordHandicrafts](http://www.youtube.com/user/AshfordHandicrafts)



### Facebook

Join us on facebook.  
[www.facebook.com/ashford.wheels.looms](http://www.facebook.com/ashford.wheels.looms)

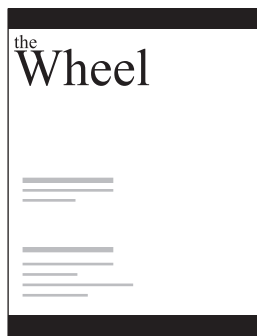

### The Wheel Magazine

Ashford's annual fibrecraft magazine. Spinning, weaving, felting, dyeing and knitting projects, patterns and articles from around the world. To receive the glossy version delivered to you, subscribe at:  
[www.ashford.co.nz/subscribe](http://www.ashford.co.nz/subscribe)

### Ashford Guarantee

Thank you for purchasing this Ashford product. In the unlikely event there is any fault in manufacture, please contact the dealer you purchased it from. To validate the guarantee, please go to [www.ashford.co.nz/product-registration](http://www.ashford.co.nz/product-registration)