

# Learn to fringe twist

fringe twist sliver



# FRINGE TWISTING SLIVER

Make a perfect twisted fringe on scarves, handwoven garments or needlework projects. Create cording from cotton or twist sliver for fibre craft projects. Add beads and metalics for texture and fun.

01



02

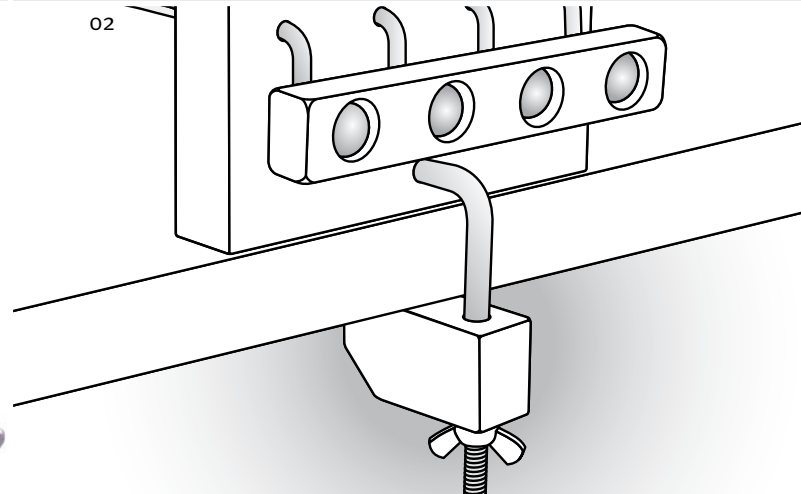

Clamp twister on a table.

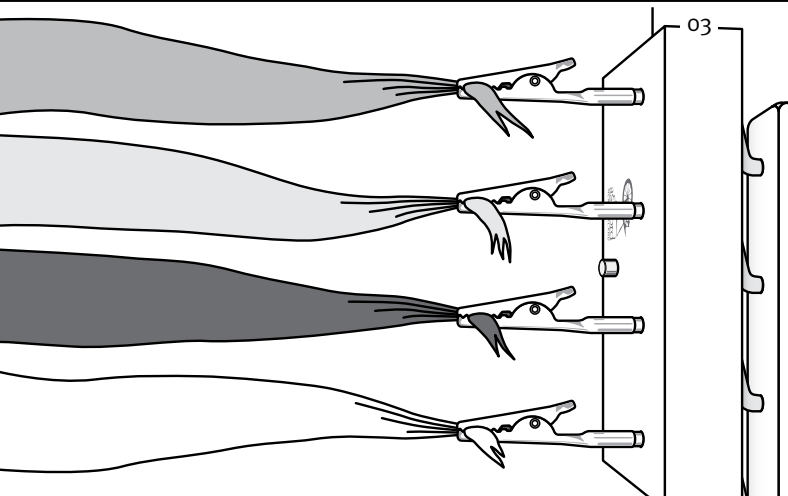

Divide the sliver into even thicknesses and clip onto the fringe twister.

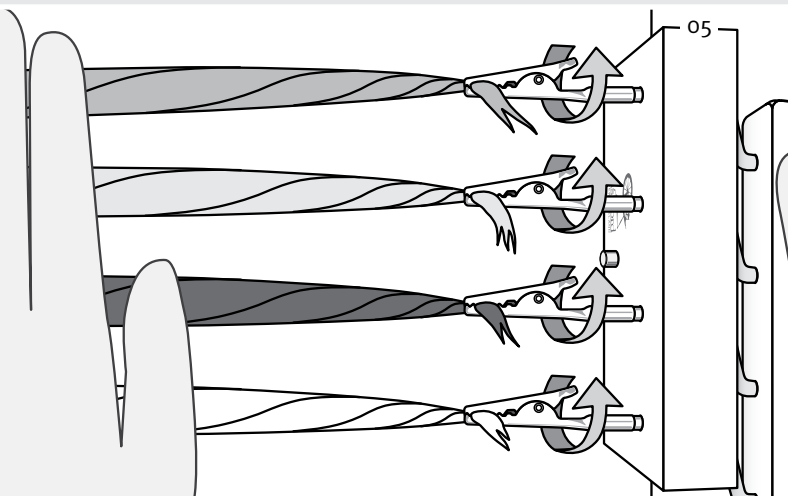

Place a hand on the ends of the sliver and rotate the handle clockwise until the sliver is twisted.



07

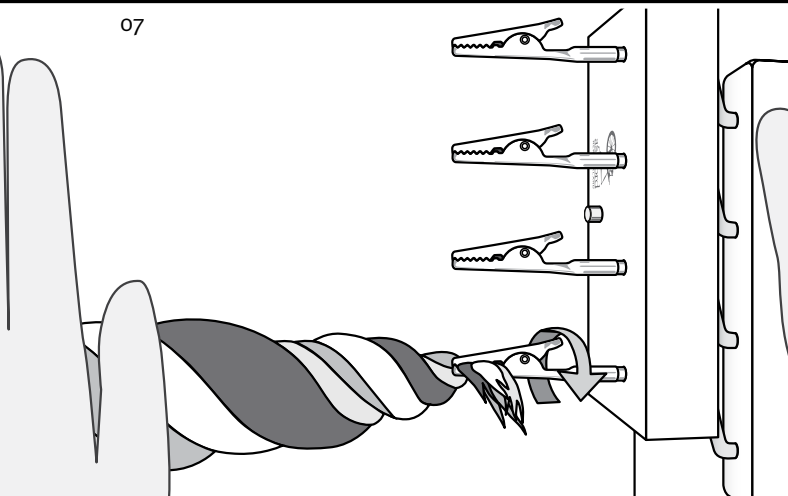

Holding onto the ends, unclip and place all four opposite ends into one clip and rotate anti-clockwise.

08



09

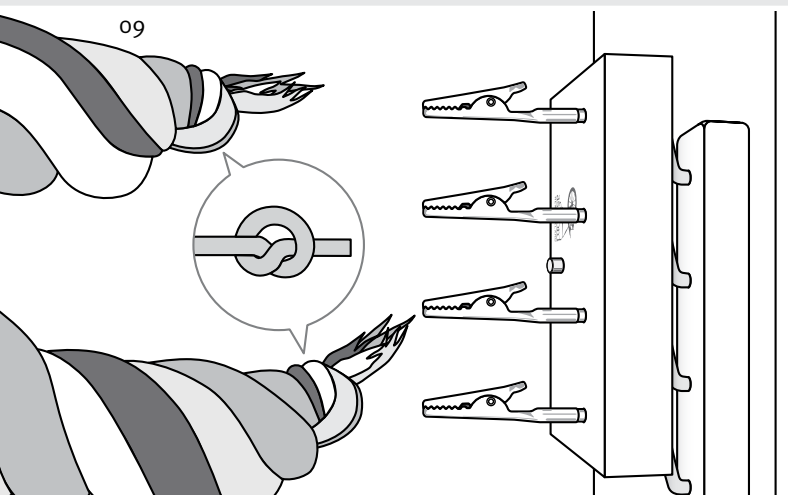

Tie a knot in each end and secure.  
Hint: Twisted sliver can be felted by hand or in your washing machine.

10





# Books available from Ashford



The Ashford Book of Weaving for the Four Shaft Loom  
By Anne Field



The Ashford Book of Rigid Heddle Weaving  
By Rowena Hart



The Ashford Book of Weaving for Knitters  
By Rowena Hart



The Ashford Book of Projects



The Ashford Book of Projects for the Eight Shaft Loom  
By Elsa Krogh

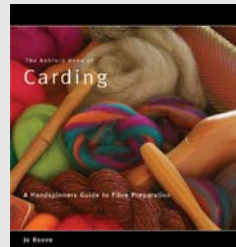

The Ashford Book of Carding  
By Jo Reeve



The Ashford Book of Dyeing  
By Ann Milner



The Ashford Book of Hand Spinning  
By Jo Reeve



Weaving on the Ashford Knitters Loom DVD



Learn to Spin Booklet



Learn to Weave on the Rigid Heddle Booklet



Learn to Weave on the Knitters Loom Booklet

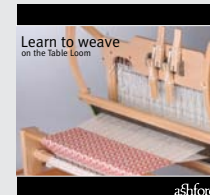

Learn to Weave on the Table Loom

# ashford

WHEELS & LOOMS

**Ashford Handicrafts Limited**

Factory and Showroom: 415 West Street

P O Box 474, Ashburton, New Zealand

Telephone: +64 3 308 9087

Facsimile: +64 3 308 8664

Email: [sales@ashford.co.nz](mailto:sales@ashford.co.nz)

Internet: [www.ashford.co.nz](http://www.ashford.co.nz)

